

INSTALLATION, MAINTENANCE & SERVICE BULLETIN

INSTALLING THE BRAKE CHAMBERS (BOOSTERS)

The following information is for installing a FKH brand of double diaphragm spring brake chamber with a **manual** slack adjuster.



Note: For auto slack adjuster installations go to: Bulletin KPM-001-0312

1. The FKH brake chamber is supplied with the push rod fully extended (NOT caged).
2. Depending on the brake force required (brake calculation), install the brake chamber in the appropriate bracket hole position.
Nut torque 150-200lbft.

HOLE CODE	SLACK ADJUSTER
A-A	/
B-A	5"
B-B	5.5"
B-C	6"
C-C	6.5"

HOLE CODE	SLACK ADJUSTER
A-A	5"
B-B	6"
C-C	7"
B-A	5.5"
B-C	6.5"

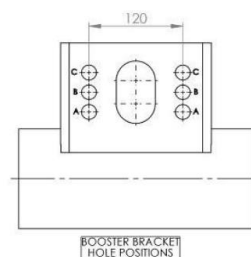

Note: The HOLE CODE may be different, depending on the axle.

Note: With the push rod fully extended and the brake chamber fitted to the correct mounting holes, the rod will line up with the correct hole in the slack adjuster, when the slack adjuster is at 90° to the push rod.

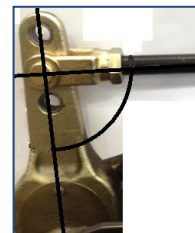

3. Mark the **push rod in the fully extended** position (double acting: no air, not caged, single acting: apply air) to the dimension in the table below and cut it. Clean and chamfer the end of the cut rod.

FKH Axle Model - axle tube size in mm	Booster rod cut length (mm) for slack adjuster setting of:		
	5" / 127mm	6" / 152mm	7" / 178mm
KF21/22 – Ø 127	246	239	234
KF21/22 – Ø 146	220	215	210
KF21 – sq 127	n/a	226	224
KF37 – Ø 127	205	200	N/A
KK44 – Ø 127 BCB - A	180	175	N/A
KK44 – Ø 127 BCB - B	230	220	N/A
KF61/67/75/85-sq150	n/a	240	238
KI Module – Ø 146 long cam	220	215	210
KI Module – Ø 146 short cam	n/a	304	300
Self Steer Trailer Axle	n/a	188	183



Brake Chamber Bracket :

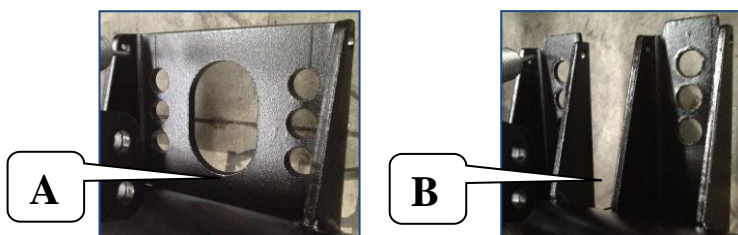

INSTALLATION, MAINTENANCE & SERVICE BULLETIN

Note: The rod lengths are the same for manual and auto slacks!

4. After the push rod is cut to the correct length, install the lock nut and clevis (as per photo →) and insert the clevis pin through the slack adjuster hole.
5. Now, follow the BRAKE ADJUSTMENT (see Bulletin KPM-008-0410).
6. To check the final installation; use the following table which contains the ideal dimensions with the booster and slack adjuster installed with the brakes applied.

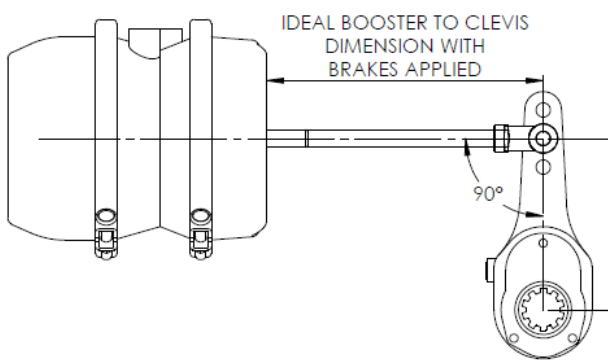
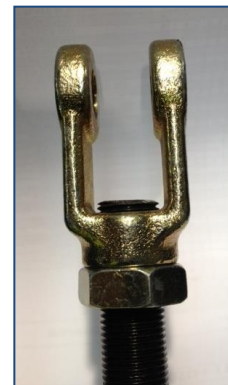

Axle Model and axle tube size in mm	Approx. booster to clevis pin dimension (mm) with brakes applied.
KF21/22 – Ø 127	246
KF21/22 – Ø 146	225
KF21 – sq 127	235
KF37 – Ø 127	199
KK44 – Ø127 BCB - A	176
KK44 – Ø127 BCB - B	215
KF61/67/75/85-sq150	247
KI Module – Ø 146 long cam	225
KI Module – Ø 146 short cam	310
Self Steer Trailer Axle	200

7. There can be situations where the brake is not required (brake off), but no air is available to pressurize the spring brake chamber to release the spring.

When this situation arises, the spring needs to be mechanically retracted with the “spring brake release adapter”, which is stored on the side of the brake chamber.

Warning: Automatic spring brake will be disabled!!

Remove the adaptor and insert it in the back and twist it a ¼ turn and tighten the nut.

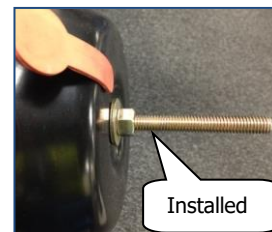
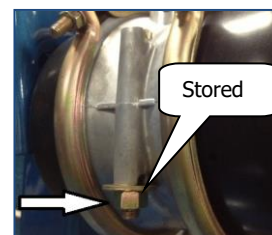
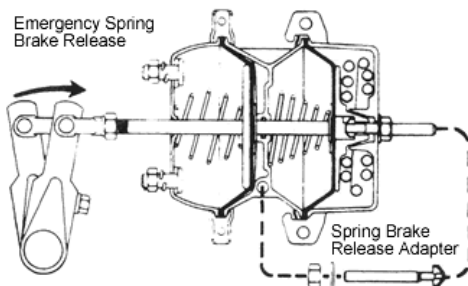

For more brake information go to bulletin: KPM-008-0410