

## INSTRUCTION FOR MECHANICAL SUSPENSIONS

### 1. Safety Procedures and Information

#### Safety First

Be sure to read and follow all installation and maintenance procedures.

#### 1.1. Lifting

Practice safe lifting procedures. Consider size, shape and weight of assemblies. Obtain help or assistance of a crane and licensed operator when lifting heavy assemblies. Make sure the path of travel is unobstructed before lifting or moving an assembly. Always wear appropriate safety clothing and equipment to prevent injury in the event of an accident.

#### 1.2. Welding

When welding, be sure to wear all personal protective equipment for face and eyes. Ensure that the work area has adequate ventilation and visual protection for passers by. When welding, protect the spring beams and air springs from weld spatter and grinder sparks. Do not attach "ground" connections to springs.

Under normal use, steel presents few health hazards. However, prolonged or repeated breathing of iron oxide fumes produced during welding may cause bad health.

#### 1.3. Overloading

Overloading is the practice of transporting a load that exceeds the design specified ratings of that vehicle. Overloading can cause component failure resulting in accidents, injuries and even death.



This symbol indicates that the reader should pay special attention to the specific requirements or warnings stated.

## INSTALLATION, MAINTENANCE & SERVICE BULLETIN

### 1.4. Torque

Proper tightening of the U bolt nuts and alignment bolts are high priority items. A fastener system is considered to be loose if the torque is found to be less than that specified by the manufacturer. Failure to maintain the specified torque and to replace worn parts can cause component failure resulting in accident with consequent injury.



**It is extremely important that after the first 1500 – 4500 loaded kilometres of travel, and with each following annual inspection, that all of the bolt and nut torque recommendations be checked. Any loose fasteners must be re-torque to comply with warranty requirements and to ensure a long, trouble free life of the system**

#### 1.4.1 Torque Wrench

Torque wrenches must be calibrated every 12 months by an accredited company.

### FOR YOUR RECORDS

DATE UNIT ENTERED SERVICE:

\_\_\_/\_\_\_/\_\_\_\_\_

DATE OF FIRST SERVICE (1500-4500 LOADED KMS)

\_\_\_/\_\_\_/\_\_\_\_\_

# INSTALLATION, MAINTENANCE & SERVICE BULLETIN

## 2. Installation

### 2.1. Hanger Installation

Using your axle spread and the technical drawings supplied, determine the center to center dimensions of the hangers for your suspension system. Mark the center position of an equalizer hanger on the chassis as per your requirements.

Detailed requirements for hanger installation are shown in the figures shown below.

Measure and mark the centers of the remaining hangers from the first as per the technical drawing for your suspension system. Tack weld the hangers in place, ensuring that the hangers are square on the chassis and that the hangers line up along the chassis rails (**within 1.5mm**)

NOTE:

For all suspension systems, the radius rod hole on the front hanger must face forward, while the radius rod hole(s) on the equalizer(s) must face rearward.



**IF THE LADEN TRAILER SLOPE EXCEEDS 1:150, PACKERS MUST BE USED TO COMPENSATE FOR THE SLOPE. SEE SECTION 7 FOR MORE INFORMATION.**

Check the diagonal distances between all the hangers i.e. Front Hangers, Equalizer Hangers, and Rear Hangers. These measurements must be within  $\pm 3\text{mm}$  as shown on the technical drawings.

If these measurements are correct, insert a steel pipe cross brace through the holes on the hangers as shown in figure 2.1.1.

Also, for off highway, heavy duty and all tipper operations, attach a channel section across the front hangers as shown in figure 2.1.2.

Once the pipes and channel are in place, the operator can commence fully welding the hangers in place.

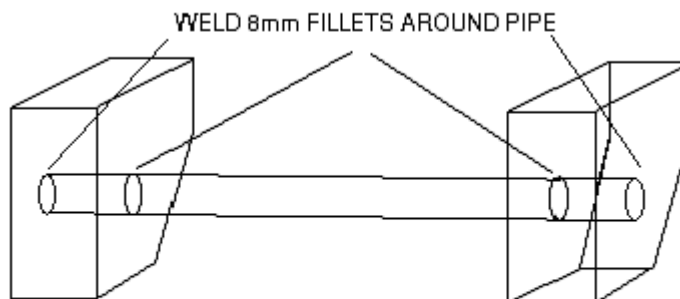

**NOTE: IF PIPES INTERFERE WITH MOVEMENT OF ROCKERS, CUT PIPE SO THAT THERE IS NO PROTRUSION INTO HANGERS AND FULLY WELD TO INSIDE OF HANGERS**

Figure 2.1.1. – Pipe installation

# INSTALLATION, MAINTENANCE & SERVICE BULLETIN

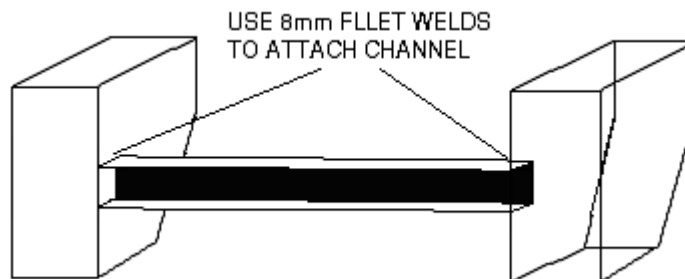

Figure 2.1.2 – Welding of channel section to front hangers

## 2.1.1. Welding instructions for welding hangers to chassis

The weld seam must be single pass, 8mm fillet weld as shown in figure 2.1.1.2  
For optimum results we recommend the customer use ESAB 7018 or low hydrogen welding rod or equivalent.

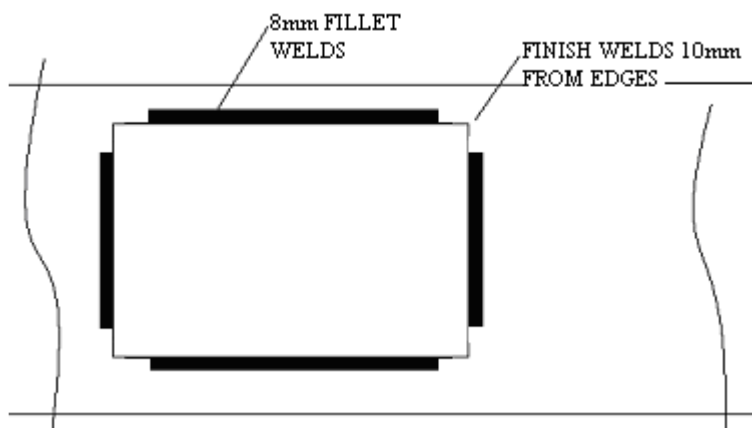

Figure 2.1.1.2 – Hanger welding procedure

## INSTALLATION, MAINTENANCE & SERVICE BULLETIN

### Axle Seat Installation

All axles must be installed so the cam shaft rotates in the same direction as the wheels during forward operation.

#### 2.2. Spring Seat Placement and Locations

This section recommends welding locations on round and rectangular trailer axles



**Improper weld placement will void the axle warranty and can result in reduced fatigue life of the trailer axle beam and cause serious injury**

***Note: See section 3 for information on welding recommendations.***

Position the axle seats on the axle at the correct spring spacing as per the width of the hanger centers on the chassis. Center of each bolt hole must be at top center of axle for overslung suspensions and bottom center for underslung suspensions. Ensure that the seats are parallel with each other as well as being parallel with the ground. Clamp the seats in place and tack weld.

Recheck the seat positions and weld the axle seat to the axle as per the drawings shown below.

# INSTALLATION, MAINTENANCE & SERVICE BULLETIN



**Specific Welding procedures are required for installation.**

Ø127mm Round Axle

Overslung

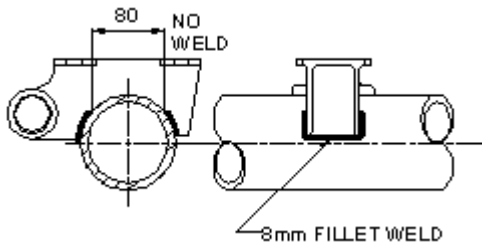

Underslung

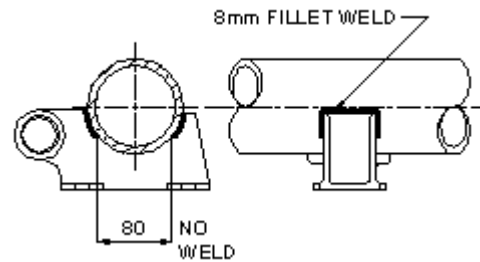

150x150mm Square Axle

Overslung

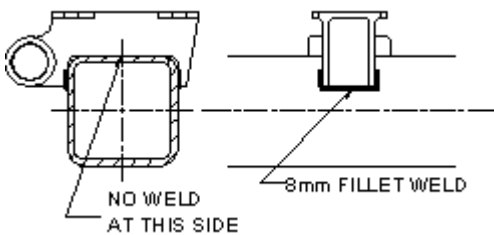

Underslung

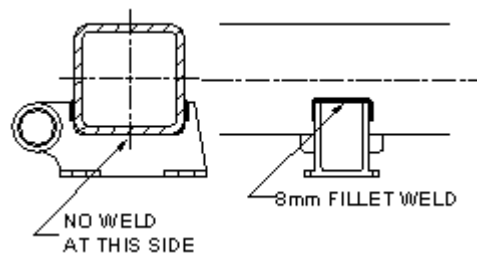

Welding requires 8mm fillet welds. For optimized results we recommend the use of low hydrogen electrodes or MIG process.

**NOTE: If axle manufacturer has specified a different procedure that must be followed, check with Fuwa K Hitch engineering department first.**

# INSTALLATION, MAINTENANCE & SERVICE BULLETIN

## Welding Procedures for Welding Axle seats

The welding rod must generate tension test strength of 70,000psi. Normal methods and electrode classifications are shown in table 2.4.1. To obtain the best fusion and the strongest weld use the voltage and current settings recommended by the electrode manufacturer.

METHOD FOR WELDING CARBON & LOW ALLOY STEEL	AWS* ELECTRODE CLASSIFICATION	AWS SPEC.
Shielded Metal Arc	E70XX	A5.1, A5.5
Gas Metal Arc	ER70S-X	A5.18
Gas Tungsten Arc	ER70S-X	A5.18
Flux Cored Arc	E70T-X	A5.20

Table

The maximum weld bead size permitted, regardless of the number of passes, is 9.5mm on rectangular axles and 12.7mm on round axles.

Excessive welding to the axle should be avoided. Fitting the attaching parts as neatly as possible to the axle will help reduce excess welding.

Complete required welds using the least number of passes and if multiple passes are used, thoroughly clean the weld between passes.

Weld beginnings and ends should be performed as shown in Fig 2.4.2.

- The weld arc should not be started at either end of the bead. Instead the electrode should be started away from the ends of the bead as shown.
- The weld arc should not be finished at either end of the bead. Again the electrode should be finished away from the ends of the bead as shown. Any craters that remain should be filled during this movement.
- In both cases, the intention is to remove stress increasing operations, such as the starting and ending of an arc, from high stress areas such as the ends of the welds

## INSTALLATION, MAINTENANCE & SERVICE BULLETIN

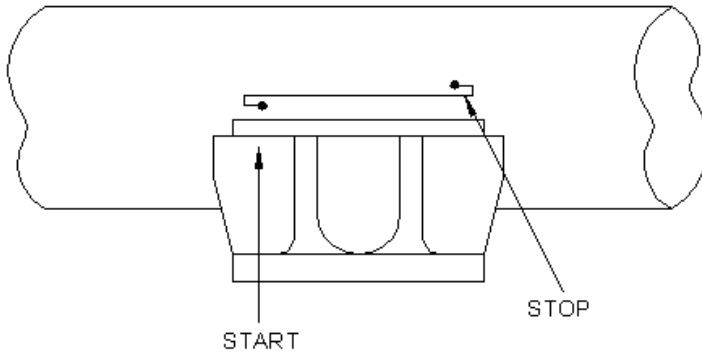

Figure 2.4.2

Do not test the weld arc on any part of the main axle beam. This can cause a material change and lead to fatigue cracking of the axle beam.



**Do not connect the earth cable to any part of the axle assembly that will put a wheel bearing between the ground cable and weld area. If this does occur, the wheel bearing will be damaged by electrical arcing.**

Earthing of the axle should be done on one of the parts attached to the axle such as the booster brackets, camshaft support brackets or the brake spider.

Connections should be tight and clean.

The area to be welded must be clean and free of grease, dirt or other contaminants that might affect the quality of the welds.

Brackets that wrap around the axle should touch the axle as shown in Figure 2.4.3, view A. With this type of fit, loads on the bracket are transferred directly to the axle. The bracket as shown in figure 2.4.3 view B would transfer the load through the weld. This may overstress and crack the weld.

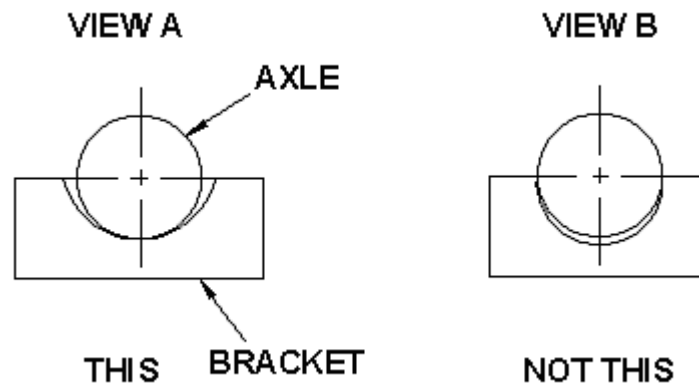

Figure 2.4.3

## INSTALLATION, MAINTENANCE & SERVICE BULLETIN

When a bracket is attached to an axle with U bolts and a weld, tighten the U bolts whenever possible to the specifications of the manufacturer before welding. This ensures that the loads in the bracket are not transferred in the weld. Distortion and residual stresses that happen when welding parties to the axle can be minimized by tack welding the parts to the axle before fully welding, as shown in figure 2.4.4. Be sure to thoroughly clean the slag from the tack welds before applying the final welds.

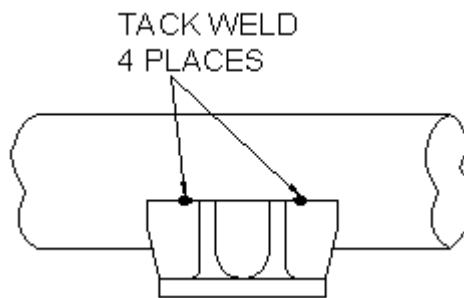

Figure 2.4.4

### 3. General Welding Information

#### 3.1. General Information

FUWA axle beams are made of a low alloy steel and are formed using integral hot forming technology. Hence, it has a longer fatigue life and superior welding qualities. FUWA round axles provide a uniform section modulus no matter how the axle is rotated.

Brake spiders are positioned and welded to exacting specification requirements at our factory. Ring welding the spider directly to the axle beam provides a higher grade, more reliable brake attachment than bolt-on versions.

#### 3.2. Stresses on Axle Beams

The loaded stresses on a beam are defined as three distinct zones. The compression stress zone (The top half), the tension stress zone (The bottom half) and the neutral stress zone (The horizontal centerline or neutral axis).

Shown in figure 3.2.1 is a graphic representation of the stress in the wall of a tube when the beam is under load. The length of the arrows "x" represents the amount of stress at a given point. From this illustration, it is evident that the two opposite stresses reduce as the neutral axis is approached.

## INSTALLATION, MAINTENANCE & SERVICE BULLETIN

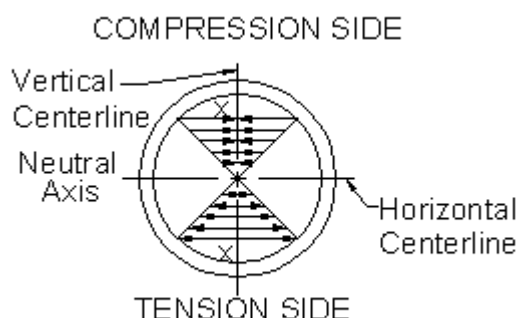

Figure 3.2.1

In addition, the torsional stress imparted on the beam during braking is also taken into consideration when rating the axle capacity. An additional allowance of both stresses due to beam loading (bending) and braking (torsional) is factored into the calculations to provide an acceptable design factor of safety.

These stresses are periodically applied and reversed many times during the normal life of the axle beam. For this reason the beam material must have certain properties, such as impact strength, that permit it to absorb shock by flexing and then returning to its original shape.

### 3.3. How Welding Affects Axle Beam Material

All welds made on the beam create, in effect, an extremely localized heat-treatment of the metal. The heat generated during the welding process can cause the material in the heat affected zone to become hardened or brittle. Welding can impart this undesirable characteristic to the normally ductile structure. Areas that may need to flex to some extent to operate properly may crack after being welded due to the effect that brittleness has on reduced fatigue handling. This small hardened area becomes the weakest section.

For this reason, it is necessary when welding to avoid the high stress areas in the compression stress zone and the tension stress zone. All welds should be kept as close to the neutral axis as possible. Welds on the axle should preferably be along the axle, rather than circumferential to avoid unfavorable weakness in the axle structure. If circumferential welds are needed, the area below the horizontal centerline of the axle cross section (the tension side) should be avoided.

### 3.4. Preheating Requirements

***Absolutely no welding should be done on axles that are below room temperature (20°C).*** Before welding on suspension components or any other part on to the axle, the area of the attachment point should be warmed slowly to 200-250°C. After checking the temperature, the part(s) should be tack welded in place immediately. Recheck the temperature. If the temperature has dropped below 180°C, reheat to 200-250°C and complete welding as per instructions.

## INSTALLATION, MAINTENANCE & SERVICE BULLETIN

### 3.5. Axle Beam Repairs

In the interest of safety and preserving the service life of trailer axle and suspension assemblies, Fuwa recommends that trailer **axle beams should NOT be repaired** by welding or any other means. Welding the axle beam will affect any heat treatment of the beam and be detrimental to the structural integrity of the components of the axle. For these reasons a damaged axle beam should be replaced with a new beam as soon as possible.

### 3.6. Axle Assemblies

Fuwa supplies axles to customers at all stages of assembly, from bare axles through to complete axle assemblies. As such we have no control over the assembly of incomplete units by trailer manufacturers and therefore we cannot be responsible for warranties on improperly assembled components.

### 3.7. Torque Arm Assembly

Assemble the adjustable torque arms to the same length as the fixed torque arms. Fit the fixed torque arms on the curb side and the adjustable on the driver's side. Fit the end of the torque arm in the bracket and insert the bushes\* from each side. *(Lubricate all tapered rubber and poly bushes on the taper surfaces with a liquid soap solution (50% liquid soap – 50% water) we DO NOT recommend any other lubricants – e.g. Rubber grease, Detergent etc.*

Fit pin, washers and nut, ensuring that the torque arm is central in the bracket. Tighten torque arm pin lock nuts to 150-200Nm.

For better bush durability, ensure correct location of the torque arm and avoid metal to metal contact (see Photo A – example of a good installation).

It may be necessary to fit special spacers (Photo C) to prevent the TA being pulled to one side and prevent excessive build up of bush material between the TA and the bracket and under the bolt head or the nut washers. (Photo B – example of a bad installation)



Photo: A

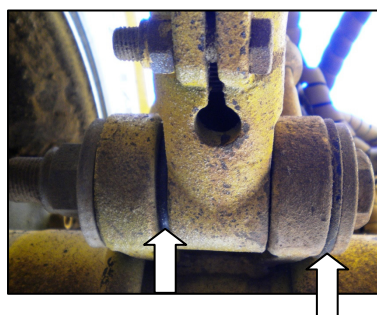

Photo: B

## INSTALLATION, MAINTENANCE & SERVICE BULLETIN

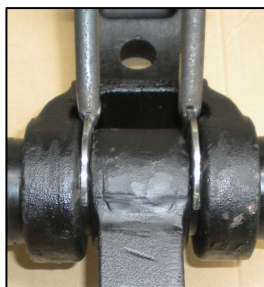

Photo: C

Ensure the bushes are installed without being damaged at installation! (Photo: D)



Photo: D

For the adjustable torque arms tighten the clamp bolts after the torque arm pin lock nuts have been fully tighten – to ensure they are not twisted and load up the bushes.

**Note:**

On multi-axle suspensions, the centre and rear torque arms will be longer than those on the front axle.

On all underslung suspensions the adjustable torque arms must be installed with the clamp bolts to the top as shown.

\*Rubber bushes are a standard for most highway applications. Poly / urethane bushes are designed for heavy duty applications (rough road, heavy duty and intensive operations).

Excessive movement (up and down) of the torque arm and incorrect axle tracking (wheel alignment) will reduce the durability of the bush.

# INSTALLATION, MAINTENANCE & SERVICE BULLETIN

## 3.8. Final Assembly

Mount the springs onto the axles ensuring that;

- On the front axle, the hooked end of the leaf is to the rear of the axle. This is for all suspension.
- **On the rear axle, the hooked end of the leaf is to the front of the axle. This applies to all multi axle suspensions.**

Tighten 'U' bolt nuts evenly to a torque of 500-540Nm in cross pattern as shown in figure 3.8.1

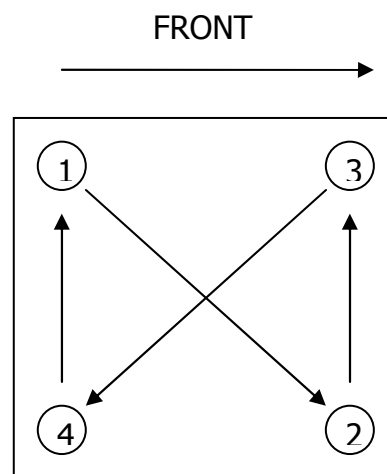

Figure 3.8.1

Fit the sub-axle assemblies in to position and connect the torque arms to the front and equalizer hangers.

Assemble the Rocker/Equalizer Bushes (Equalizer shaft fastener nuts 290-350Nm), centralised the rocker cover and lube the bushes. (*Lubricate all tapered rubber\* and poly bushes on the taper surfaces with a liquid soap solution (50% liquid soap – 50% water) we DO NOT recommend any other lubricants – e.g. Rubber grease, Detergent etc).*

\*Rubber bushes are a standard for most highway applications. Poly / urethane bushes are designed for heavy duty applications (rough road, heavy duty and intensive operations).

Make sure that the hooked spring leaf ends fit into the equalizer hangers and that there is adequate clearance on the equalizer boss.

Insert spring retaining bolts into the equalizers and hangers.

## Suspension Alignment Instructions

### 3.9. Final and In Service Suspension Alignment Instructions

**The following steps are recommended and necessary for proper suspension alignment.**

Release the brake system and pull the trailer forward in a straight line. This will free the trailer from any binding. Ensure that the ground is level and smooth.

For best results the use of axle extensions and a kingpin post, or a suitable optical alignment device are recommended. Align the front axle by lengthening or shortening the adjustable torque arm (located on the curb side of the trailer) with the king pin as shown in figure 4.1.1.

When the axles are aligned to  $\pm 3\text{mm}$  tighten the torque arm clamp nuts on the front axle to 90-100Nm

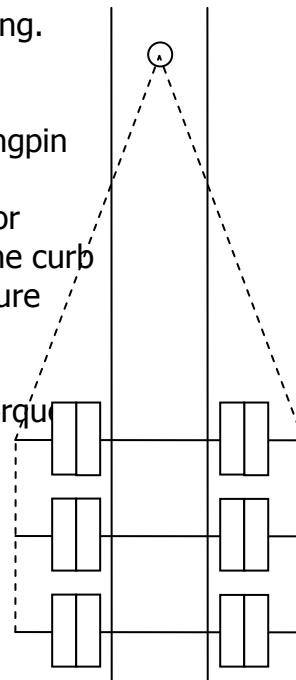

Figure 4.1.1



**Specific torque requirements are recommended**

Align each axle with the front axle to  $\pm 1.5\text{mm}$ .

**NOTE: Left side and right side axle measurements should be equal to within  $\pm 1.5\text{mm}$ . When the axles are aligned, tighten the adjustable torque arm clamp nuts on all axles to 90-100Nm.**



**Specific torque requirements are recommended**

After an initial loaded run-in period of approximately 1500km the alignment should be rechecked and corrected if necessary.

## 4. Maintenance Schedule

### 4.1. Fuwa K-Hitch Model Maintenance Schedules

The Fuwa K-Hitch leaf spring suspension, as with all suspension systems, requires regular maintenance. Periodic checks are needed to ensure continued hassle-free operation

#### 4.1.1. Recommended Maintenance schedules

- Pre – service inspection
- First service inspection, after 1500 – 4500km
- Annual inspections
- During replacement of any parts or assemblies
- Upon discovery of any loose components

#### 4.1.2. Torque requirements

- U – Bolt nuts – 500-540Nm
- Equalizer shaft fastener nuts - 290-350Nm
- Torque arm bolt nuts – 150-200Nm
- Torque arm clamp nuts – 90-100Nm
- Spring retainer nuts – 75-80Nm

#### 4.1.3. Visual Inspection

- Loose or missing fasteners
- Cracks in hangers or axle connection brackets
- Springs centered in hangers and equalizers
- Any apparent damage or excessive wear.

If any of the above defects are noted, have the vehicle checked by a qualified mechanic.

Torque values are specified with clean, lightly oiled fasteners, and should only be verified with a calibrated and certified torque wrench.

**Failure to follow these instructions could void the warranty and may result in subsequent injury.**

## INSTALLATION, MAINTENANCE & SERVICE BULLETIN

### **5. Trouble Shooting Guide and Maintenance Kit**

#### 5.1. Fasteners

Loose fasteners need immediate attention. Check components for wear and be sure that the holes have not deformed or worn in any way. When replacing any fastener, ensure that the threads are clean and undamaged and lightly oil the thread before use. Consult the maintenance section on the correct torque specifications. To ensure the correct torques, always use a calibrated, certified torque wrench.

#### 5.2. Bushings

Inspect rubber bushings for large splits, tears and major wear. Rubber is degraded by sun, oils and greases. Replace any bushings that have visible damage.

Always use non-petroleum based lubricants for installation.

### **6. Fuwa K-Hitch Tri-Axle Suspension Mounting Slope Considerations**

Investigations into the performance of trailers fitted with tri-axle suspensions have shown that installation is more critical than for tandem suspensions.

After installation the horizontal position of the suspension when under load must not deviate by more than  $\pm 0.6\%$  when measured horizontally along the length of the trailer.

If the trailer slope in the laden condition exceeds this maximum deviation the travel of the equalizers is affected, but more critical is the change in axle loadings.

High axle loadings due to incorrect load sharing can result in excessive tyre and component wear and even failure, especially during cornering. Therefore it is imperative that when installing a tri-axle suspension system that particular attention is paid to the trailer slope in laden condition. If the slope is greater than 1:150 (0.6%), packing pieces must be welded to the spring seats on the front and centre axles to compensate for the excessive slope. The deepest packer being fitted to the front axle.

The depth of packing can only be determined by considering each individual installation, the fifth wheel height, ride height, and wheelbase.

When the suspension has been matched to the design laden fifth wheel height, the maximum 0.6% variation will allow a height variation of  $\pm 50\text{mm}$  at the turntable on a 8.5m trailer.